

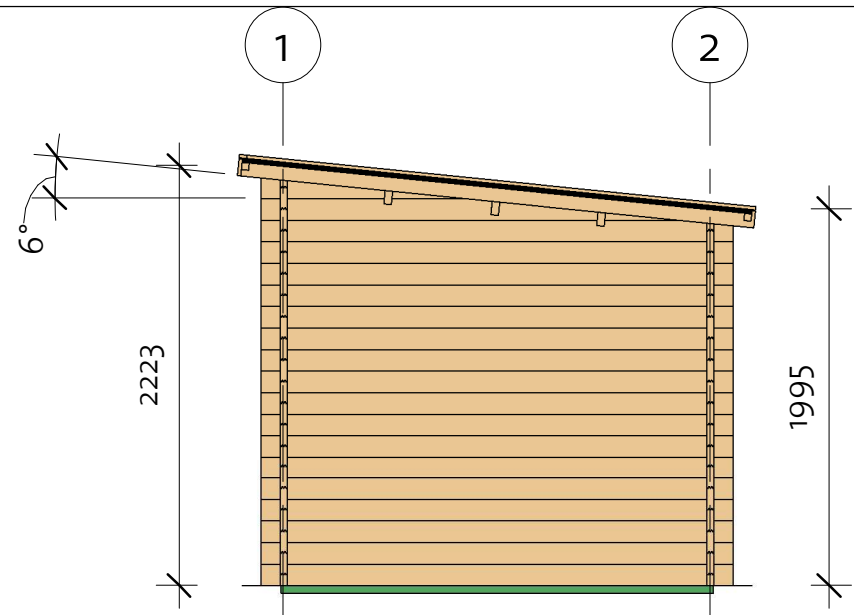

Gary 40 (578x230)

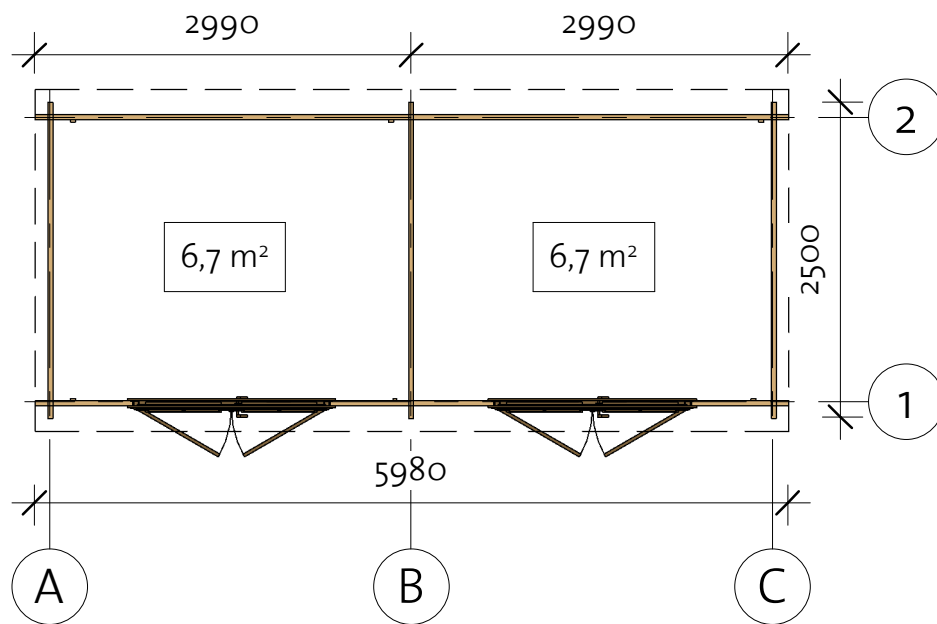

Gary 40 (578x230)

Foundation

Impregnated foundation beams				
Mark	Type	Profile	Count	Length

IFB1	IFB 70x40		3	2290
IFB2	IFB 70x40		4	2780

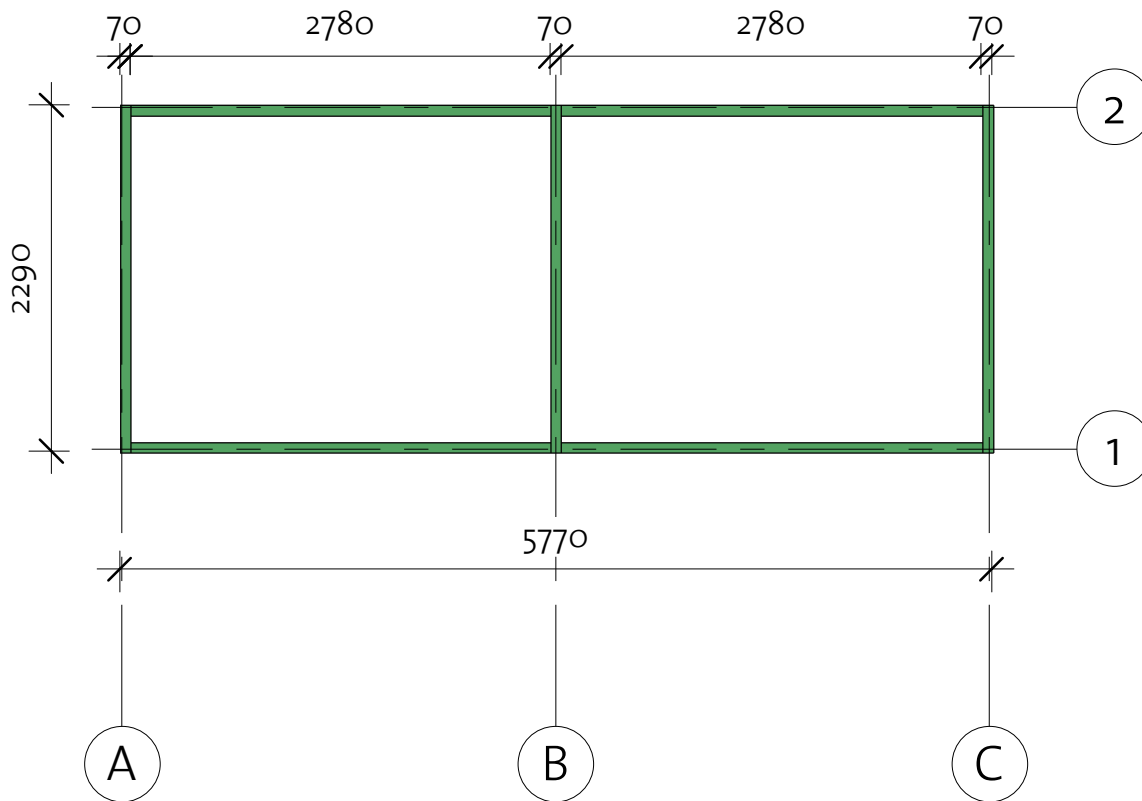

92408132_240816

Gary 40 (578x230)

Wall 1

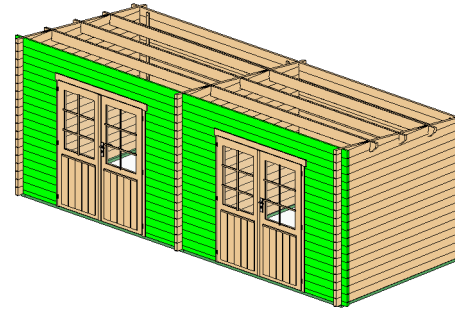

Wall 1			
Mark	Profile	Count	Cut Length

1BL-1	40X57	2	773
1BL-2	40X57	1	1305
1LG-1	40X114	32	773
1LG-2	40X114	2	5980
1LG-3	40X114	16	1305
1TL-1	40X114	1	5980

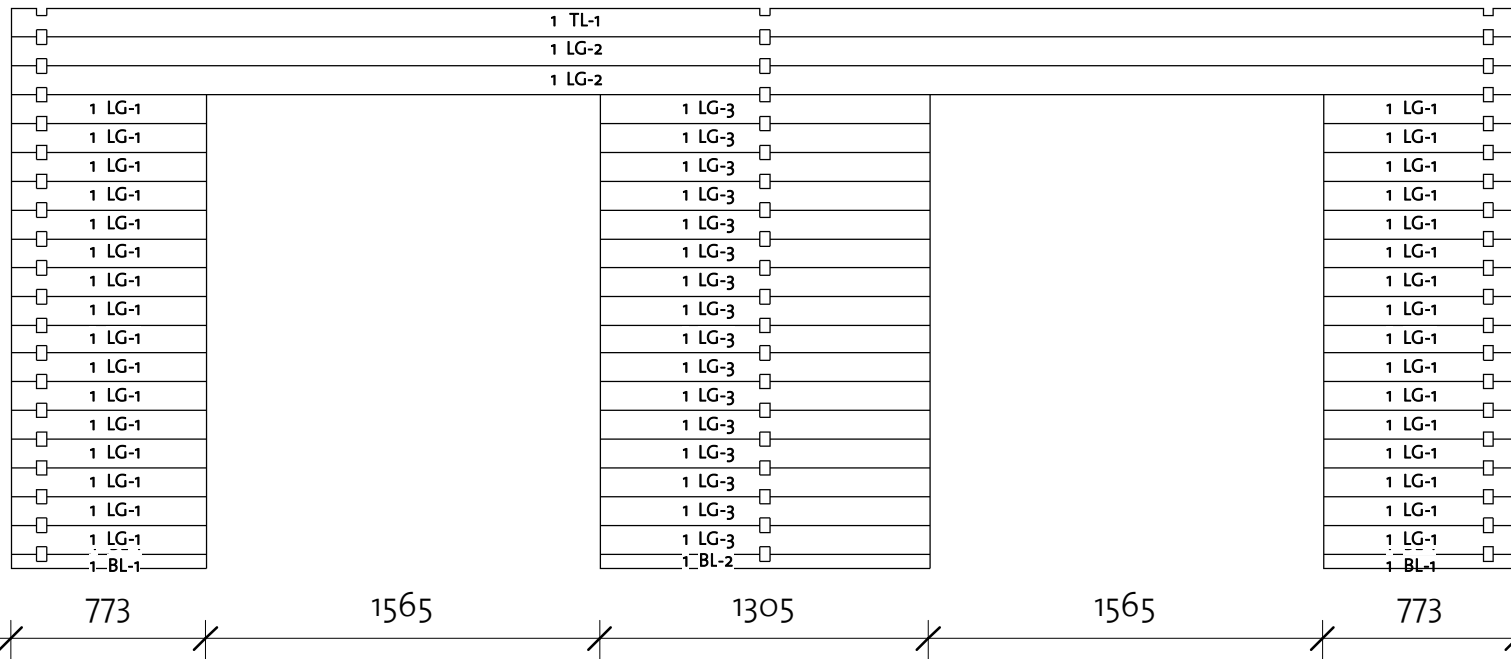

Log Profile Wall 1	
Profile	Profile

40X57	
40X114	
40X114	

Gary 40 (578x230)

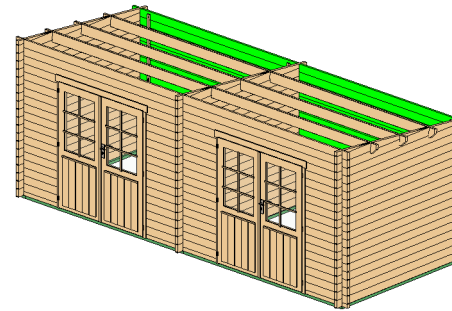

Wall 2



Wall 2			
Mark	Profile	Count	Cut Length

2BL-1	40x57	1	5980
2LG-1	40x114	16	5980
2TL-1	40x114	1	5980

Log Profile Wall 2	
Profile	Profile

40x57	
40x114	
40x114	

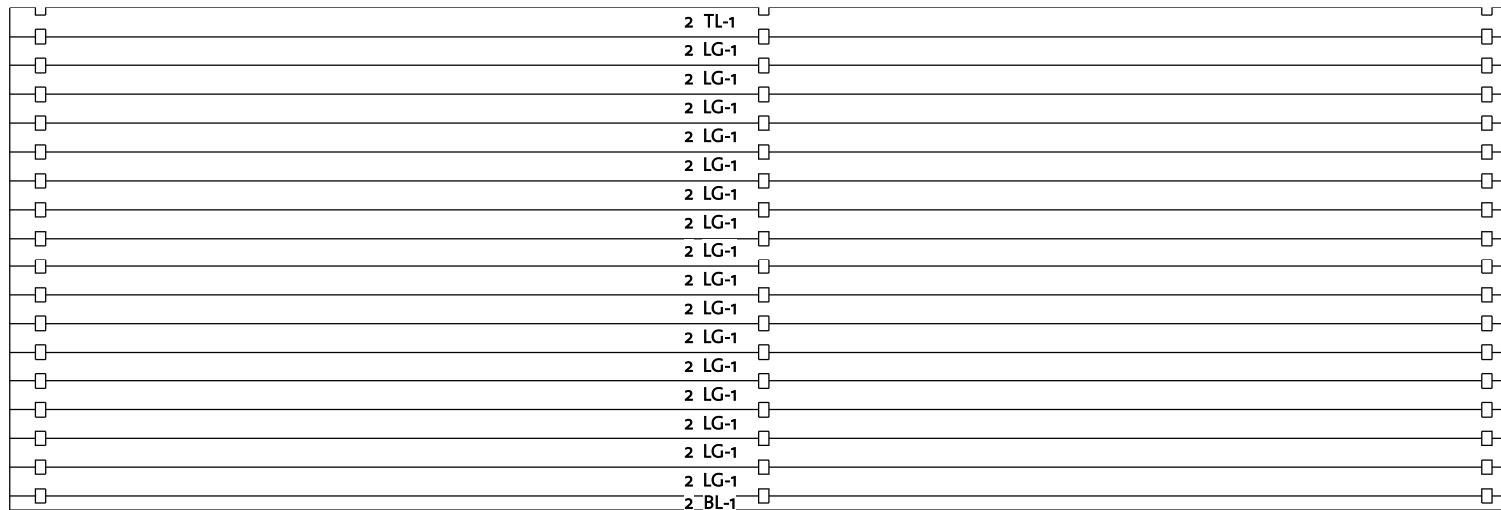

5980

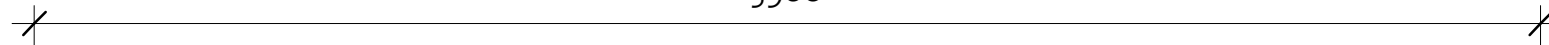

Gary 40 (578x230)

Wall A

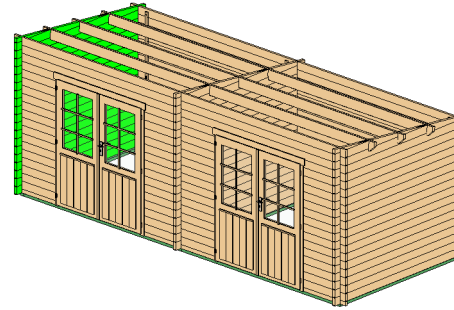

Wall A			
Mark	Profile	Count	Cut Length

ALG-1 *	40x114	1	663
ALG-2 *	40x114	1	1794
ALG-3 *	40x114	1	2500
ALG-4	40x114	17	2500

* Gable - delivered premounted

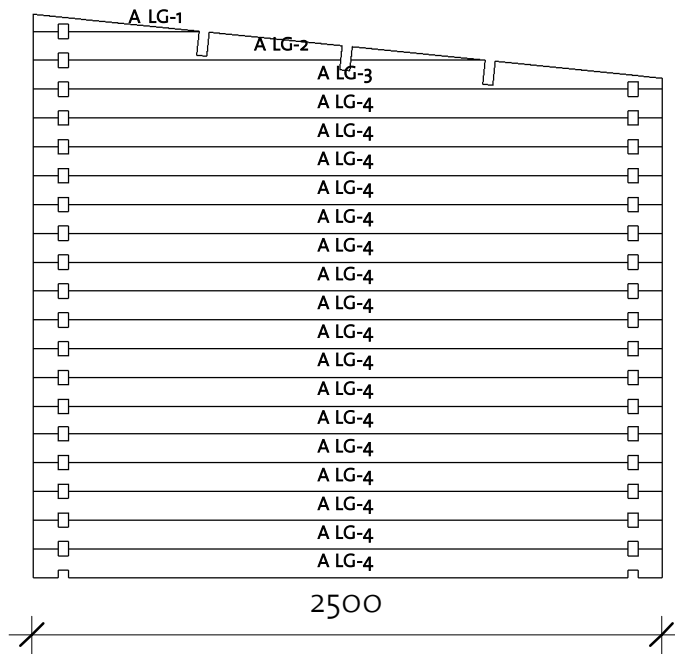

Log Profile Wall A	
Profile	Profile

40x114	
--------	--

Gary 40 (578x230)

Wall B

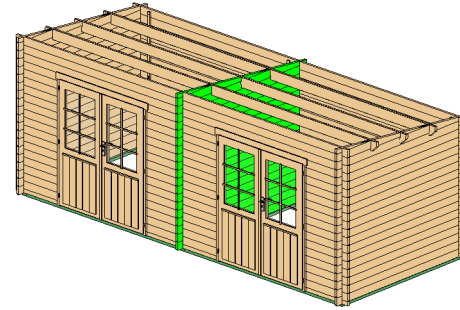

Wall B			
Mark	Profile	Count	Cut Length

BLG-1 *	40x114	1	663
BLG-2 *	40x114	1	1794
BLG-3 *	40x114	1	2500
BLG-4	40x114	17	2500

* Gable - delivered premounted

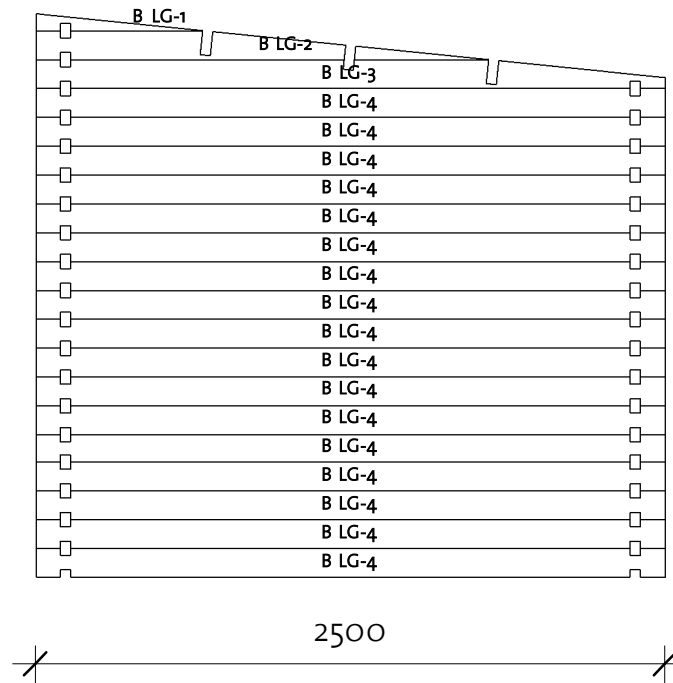

Log Profile Wall B	
Profile	Profile

40x114	
--------	--

Gary 40 (578x230)

Wall C

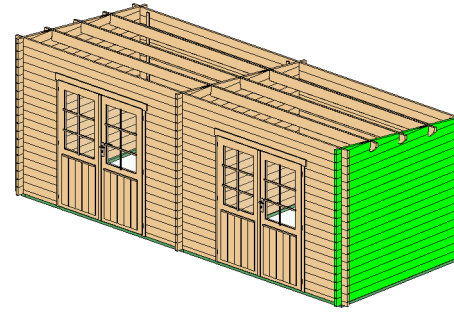

Wall C			
Mark	Profile	Count	Cut Length

CLG-1 *	40x114	1	663
CLG-2 *	40x114	1	1794
CLG-3 *	40x114	1	2500
CLG-4	40x114	17	2500

* Gable - delivered premounted





Log Profile Wall C	
Profile	Profile

40x114	
--------	--

Gary 40 (578x230)

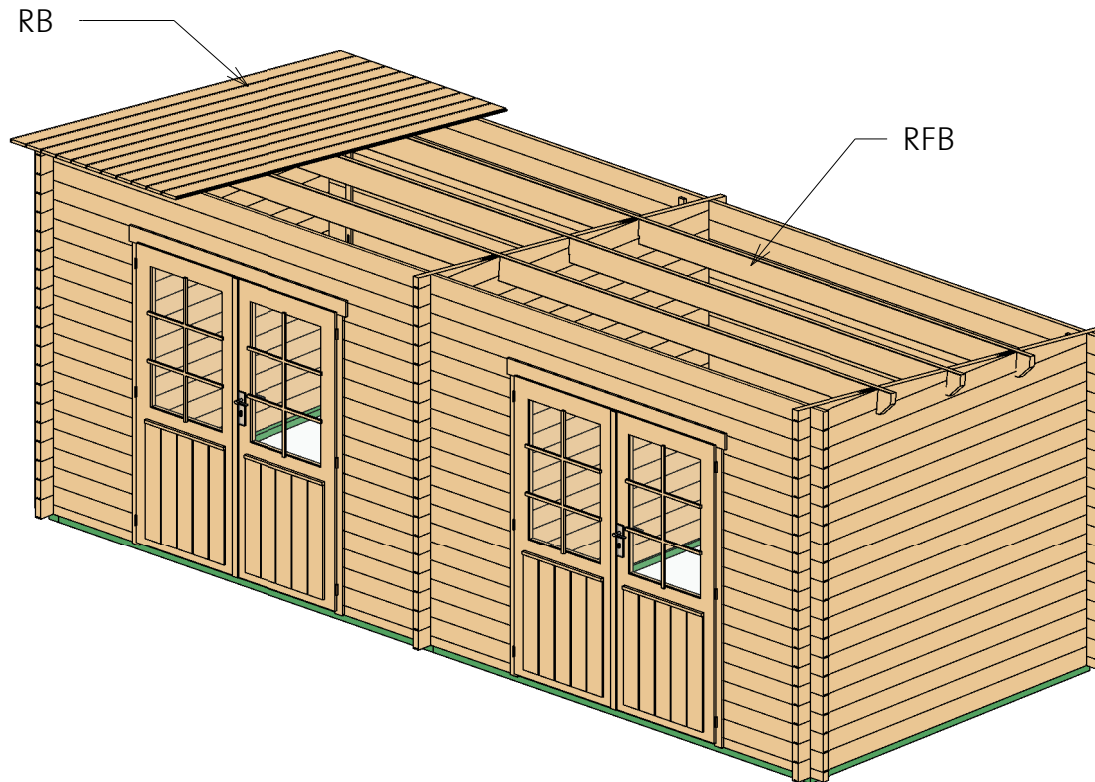
Roof 1



Roof				
Mark	Type	Profile	Count	Length
RFB	Beam 40X143		3	5980
RB	17X114		53	2712

Gary 40 (578x230)

Roof 2

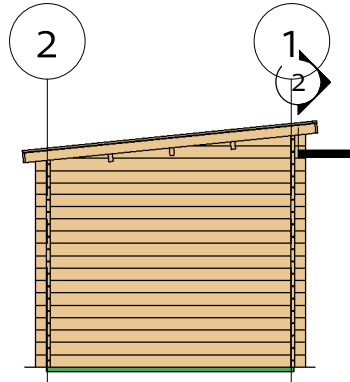

② Roof Reinforcement 1

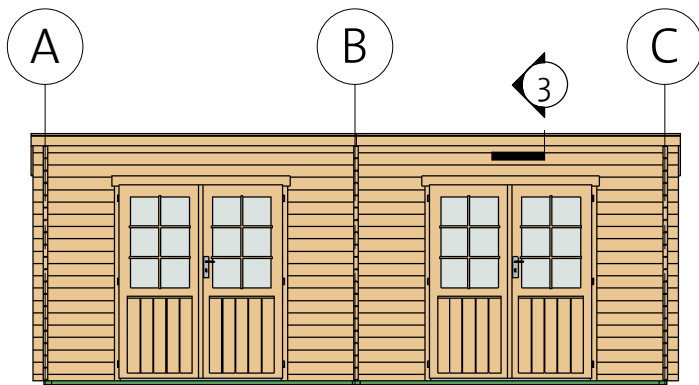
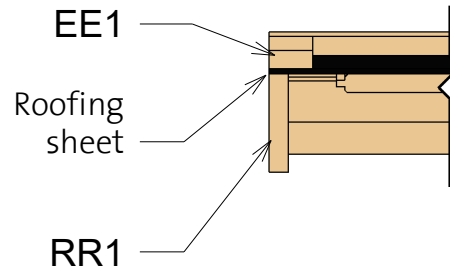

③ Roof Reinforcement 2

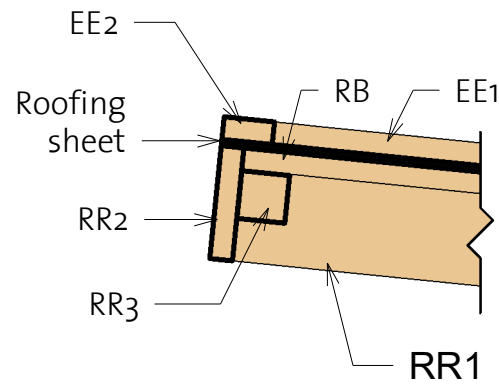

Fascia Schedule				
Mark	Type	Profile	Count	Length
EE1	Eave Edging 18x40		2	2708
EE2	Eave Edging 18x40		2	3008
RR1	Roof reinforcement 18x95		2	2712
RR2	Roof reinforcement 18x95		4	3008
RR3	Roof reinforcement 38x38		4	2990

Gary 40 (578x230)

Extras

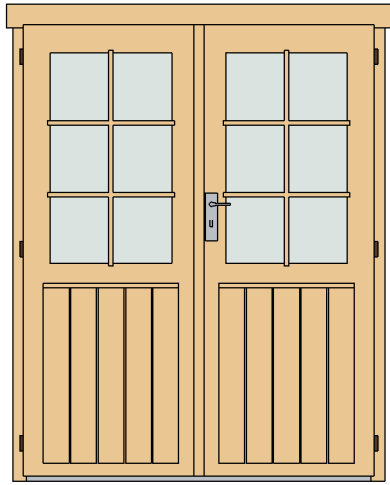

Door Schedule				
Mark	Type	Width	Height	Count
CDD20R	Classic double door 20 right	1550	1835	2
DCB6	Door Crossbar 6	--	--	4

Fasteners & Extras		
Name	Type	Count

Hitblock	300-400 mm	
Screws	5,0 x 70	15
Bolts	M8 x 70	18
Screws	6,0 x 140	40
Screws	4,0 x 40	400



Type	Count	Length
Windboard1 18x40	6	2200



Gary 40 (578x230)

List of all items 1





Roof				
Mark	Type	Profile	Count	Length

RFB	Beam 40x143		3	5980
RB	17x114		53	2712

Impregnated foundation beams				
Mark	Type	Profile	Count	Length

IFB1	IFB 70x40		3	2290
IFB2	IFB 70x40		4	2780

Fascia Schedule				
Mark	Type	Profile	Count	Length

EE1	Eave Edging 18x40		2	2708
EE2	Eave Edging 18x40		2	3008
RR1	Roof reinforcement 18x95		2	2712
RR2	Roof reinforcement 18x95		4	3008
RR3	Roof reinforcement 38x38		4	2990

Gary 40 (578x230)

List of all items 2

Wall 1			
Mark	Profile	Count	Cut Length



1BL-1	40X57	2	773
1BL-2	40X57	1	1305
1LG-1	40X114	32	773
1LG-2	40X114	2	5980
1LG-3	40X114	16	1305
1TL-1	40X114	1	5980

Wall A			
Mark	Profile	Count	Cut Length

ALG-1 *	40X114	1	663
ALG-2 *	40X114	1	1794
ALG-3 *	40X114	1	2500
ALG-4	40X114	17	2500

* Gable - delivered premounted

Log Profiles	
Profile	Profile

40X57	
40X114	

Wall 2			
Mark	Profile	Count	Cut Length

2BL-1	40X57	1	5980
2LG-1	40X114	16	5980
2TL-1	40X114	1	5980

Wall B			
Mark	Profile	Count	Cut Length

BLG-1 *	40X114	1	663
BLG-2 *	40X114	1	1794
BLG-3 *	40X114	1	2500
BLG-4	40X114	17	2500

Wall C			
Mark	Profile	Count	Cut Length

CLG-1 *	40X114	1	663
CLG-2 *	40X114	1	1794
CLG-3 *	40X114	1	2500
CLG-4	40X114	17	2500

Log Profiles	
Profile	Profile

40X114	
--------	--

Windboard

① Windboard Assembly 1



② Windboard Assembly 2

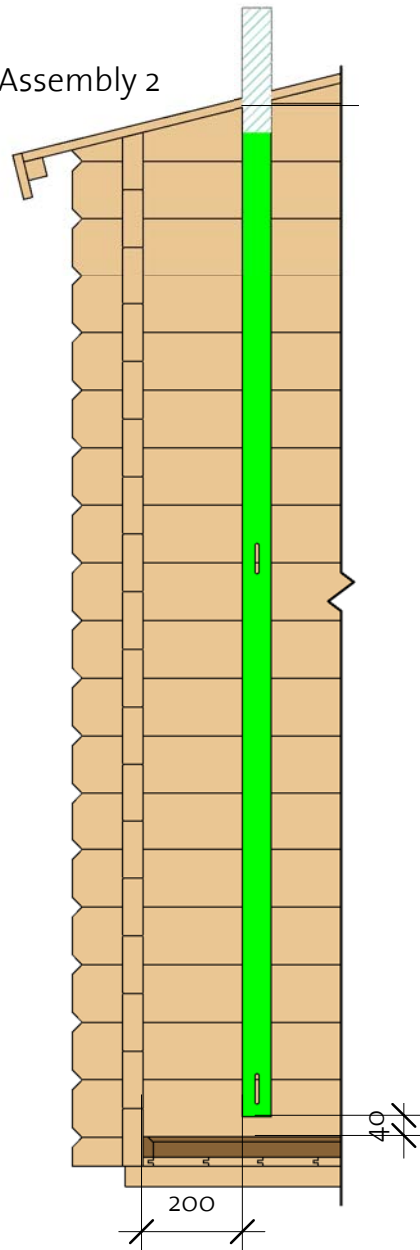

③ Windboard Assembly 3

